

Princeton 10' wide GABLE ELEVATIONS / FRAMING

SCALE: 1/4" = 1'-0"

BACKYARD PRODUCTS, LLC.

1000 Temple Dale
Morton, IL 62550

800-452-0798

Scott Beinfeld

Sept. 13, 2011

DATE: 08/24/11
DRAWN BY: Scott Beinfeld
CHECKED BY: Scott Beinfeld
SCALE: As Noted

1

NOTE:
 1. THIS WALL PLAN IS GOOD FOR THE 10' WIDE MAROO GABLE ONLY. ALL MATERIAL AND LABOR SHALL MEET OR EXCEED APPLICABLE LOCAL CODES.

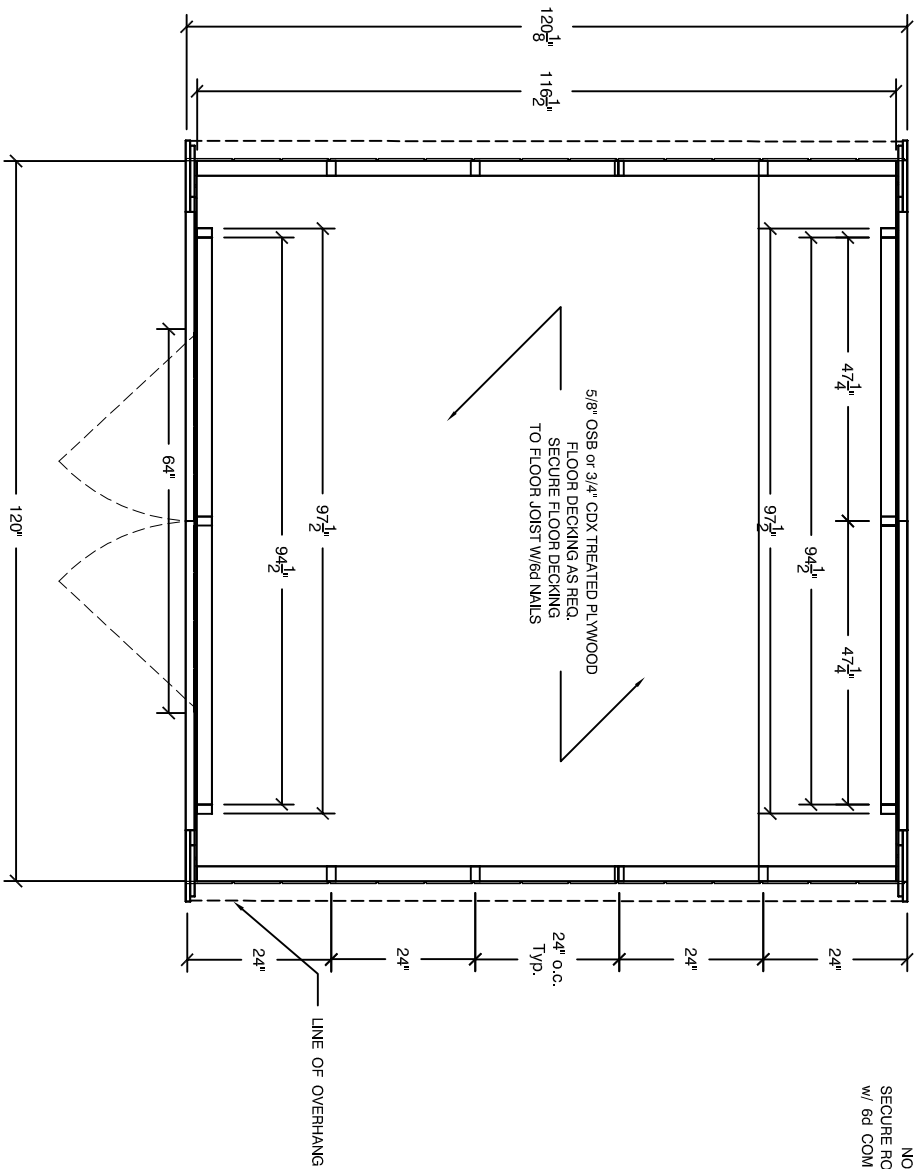

(A)
 2 TYP. WALL FRAMING PLAN
 SCALE: 3/8" = 1'-0"

NOTE:
 SECURE ROOF DECKING W/ 6d COMMON NAILS

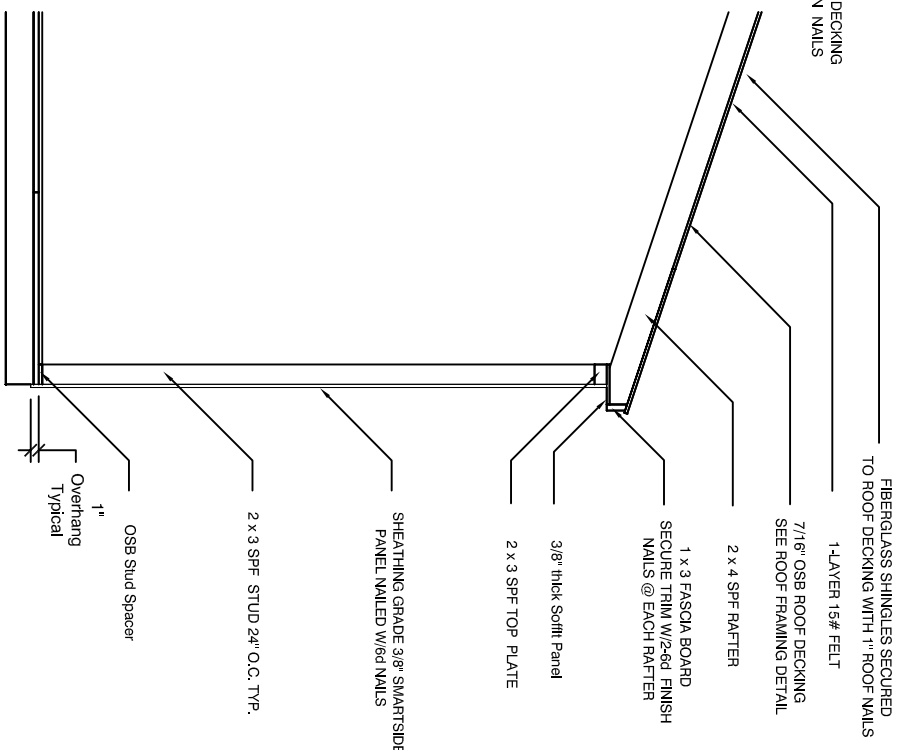

(B)
 2 WALL SECTION
 SCALE: 1/2" = 1'-0"

--	--	--	--	--	--	--	--	--	--	--



Princeton 10' wide GABLE WALL DETAILS

SIZE	ADDRESS	OWNER	DATE
D	1000 Tenth Drive Northfield, NJ 08856	Scott Bedford	Sept. 19, 2011
SCALE	As Noted	(800) 427-0796	SHEET

NOTE:
1. THIS WALL PLAN IS GOOD FOR THE 10' WIDE GABLE ONLY. ALL MATERIAL AND LABOR SHALL MEET OR EXCEED APPLICABLE LOCAL CODES.

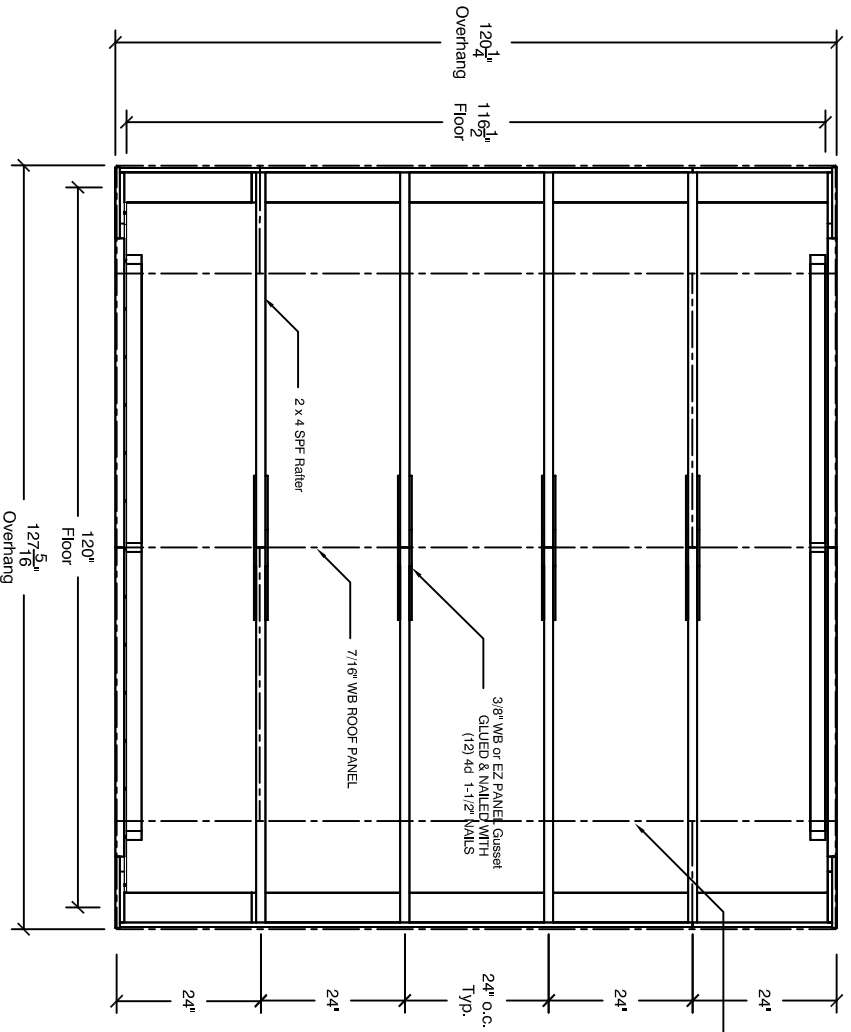

A ROOF FRAMING PLAN
SCALE: 3/8" = 1'-0"

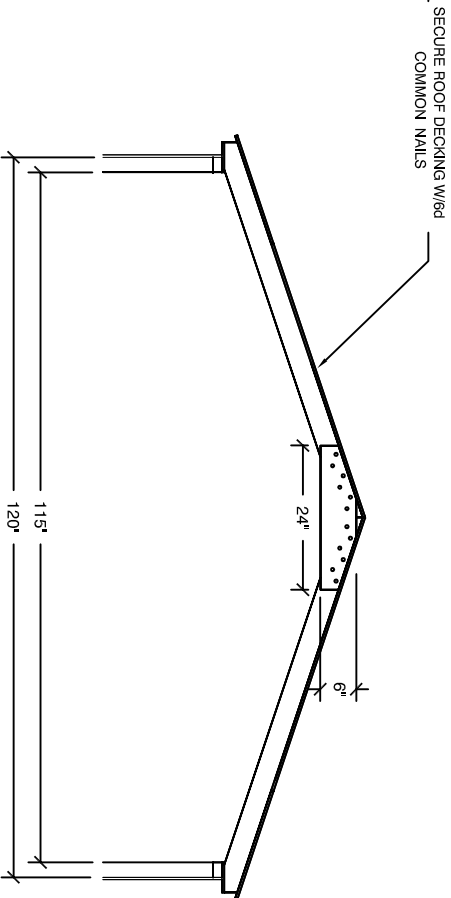

B RAFTER SECTION
SCALE: 3/8" = 1'-0"

- NOTES:
1. Approved Shingles installed per manufactures instructions with 4 nails per shingle
 2. Dripedge must overlap 2" and nailed every 12" max.

						Princeton 10' wide GABLE ROOF DETAILS	
						SHEET: D SCALE: As Noted	DATE: [] DRAWN BY: Scott Benfield LAST REVISION: Sept. 19, 2011

6'-0" MAX SPAN BETWEEN EARTH ANCHORS

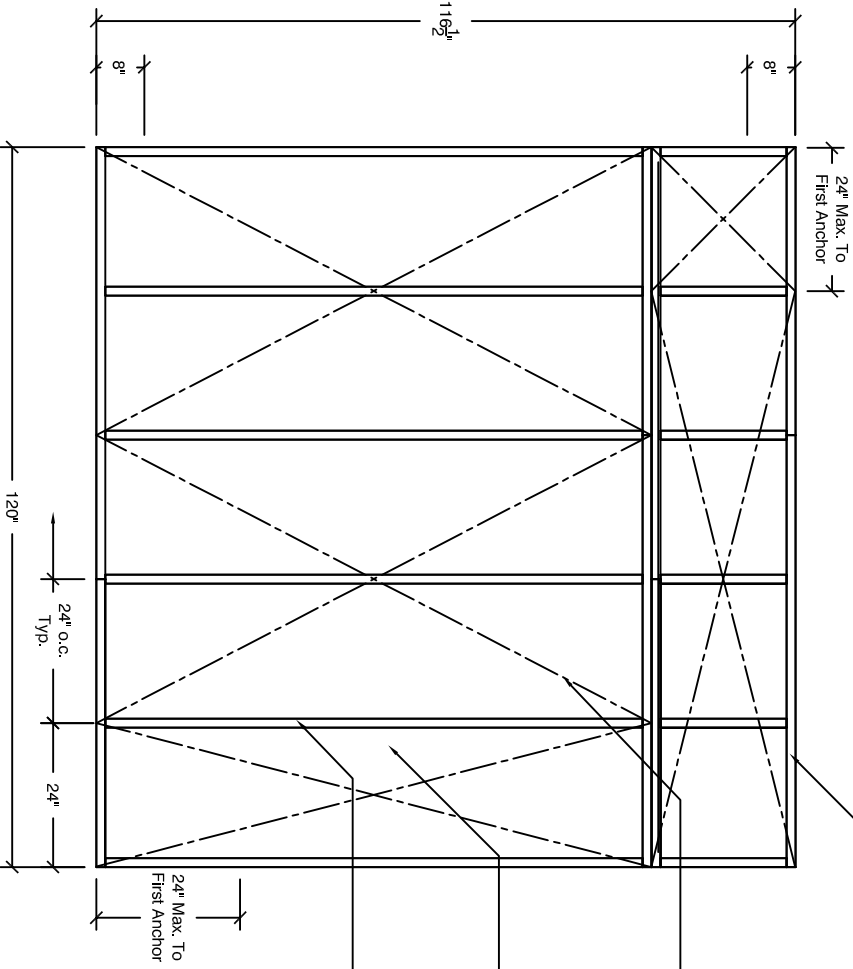

A
4 FLOOR FRAMING
SCALE: 3/8" = 1'-0"

P.T. BOND BOARD (TYP)...
SECURE BOND @ CORNERS
W/3-10d NAILS

5/8" OSB STANDARD OR 3/4" CDX TREATED PLY.
(Optional 3/4" CDX Treated Plywood)
SECURE FLOOR DECKING
TO FLOOR JOIST W/6d NAILS

4X4 P.T. RUNNERS (TYP)...
TOE NAIL FLOOR JOIST TO RUNNERS
W/2-10d NAILS @ EACH JOIST/RUNNER
INTERSECTION

P.T. JOISTS @ 16' O.C. (TYP)...
SECURE JOIST TO BOX SILL
W/2-10d NAILS @ EACH JOIST

NOTES:

1. WHEN CONCRETE SLAB IS USED, THIS FLOOR FRAMING IS NOT REQUIRED
2. ALL MATERIALS AND LABOR SHALL MEET OR EXCEED APPLICABLE LOCAL CODES.
3. ALL LUMBER TO BE NO. 2 GRADE SPRUCE PINE FIR OR EQUIVALENT.
4. THIS FLOOR FRAMING PLAN IS FOR THE BACKYARD PRODUCTS, LLC, 10' WIDE GABLE MARCO STYLE BUILDING
5. IN THE EVENT OF A DIMENSIONAL OR MATERIAL DISCREPANCY, NOTIFY BACKYARD PRODUCTS, LLC.



Princeton 10' wide GABLE
FLOOR FRAMING

SCALE: AS SHOWN	DATE: 08/07/2011	DATE PLOTTED: 09/13/2011
D	0000 Front Drive Morris, NJ 07949	Scott Benfield
SCALE: AS SHOWN	(800) 427-0724	1/2"=1'

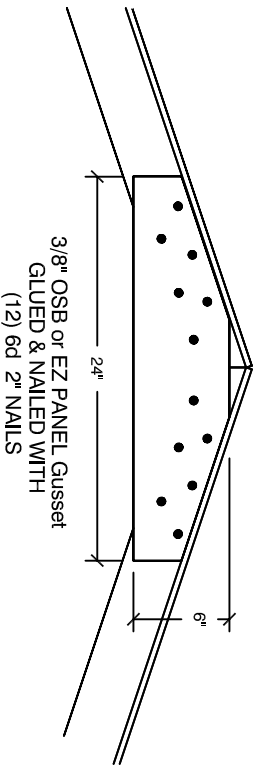

A GUSSET CONNECTION DETAIL
SCALE: 1"=1'-0"

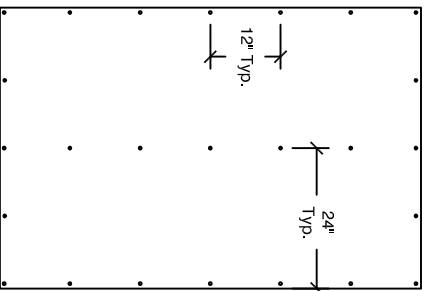
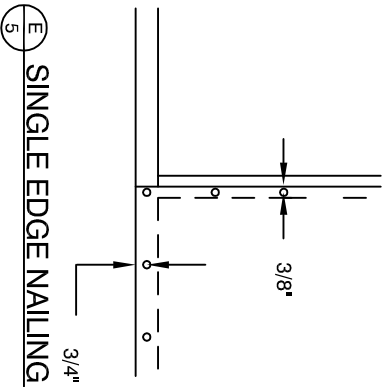

B WALL PANEL TYP. NAIL PATTERN

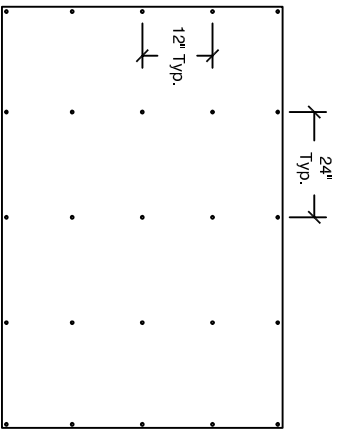

C ROOF PANEL TYP. NAIL PATTERN

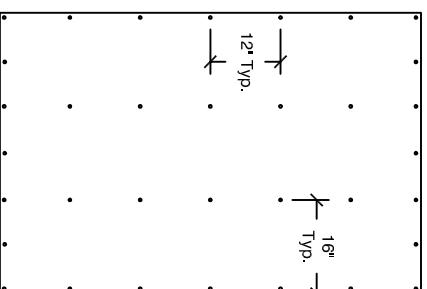

D FLOOR PANEL TYP. NAIL PATTERN

NOTES:

1. THESE STRUCTURAL DRAWINGS SHALL BE USED FOR THE CONSTRUCTION OF THE SHOWN STORAGE BUILDING. IN THE EVENT OF DIMENSIONAL DISCREPANCY, NOTIFY THE ENGINEER FOR RESOLUTION OF CONFLICT. ANY DEVIATION FROM THESE DRAWINGS MUST BE APPROVED BY THE ENGINEER.
2. MATERIALS
 - * ALL LUMBER TO BE NUMBER 2 GRADE SPRUCE PINE FIR OR EQUIVALENT.
 - * ALL PLYWOOD SHALL CONFORM TO THE LATEST EDITION OF APA SPECIFICATIONS.
 - * ALL CONNECTORS/FASTENERS AND ITS SPACING SHALL MEET THE APPLICABLE CODES.
 - * ALL MATERIALS AND LABOR PER APPLICABLE LOCAL CODES
 - * SmartSide Panel: 3/8" APA RATED (PRP-108) AS MANUFACTURED BY LOUISIANA-PACIFIC COMPANY, PORTLAND, OR, NER 124 CODE RECOGNITION.
 - * O.S.B. DECKING: 7/16" APA RATED ORIENTED STAND BOARD AS MANUFACTURED BY LOUISIANA-PACIFIC COMPANY, PORTLAND, OR.
3. THESE STRUCTURES ARE TO BE USED AS STORAGE ONLY AND NOT FOR HABITATION

10'-0" GABLE STYLE			
NOTES			
TITLE	ADDRESS	TOWN OR	DATE
D	1000 Terese Drive Merrico, WI 48106	Scott Bedford	Sept. 19, 2011
SCALE	As Noted	(800) 437-0794	SHEET

